

H122D X4 STORM

《 H122D User Manual 》

Version 1.0

2 Different Ways to Fly, 2 Configurations

1. Aircraft + HT015 Transmitter

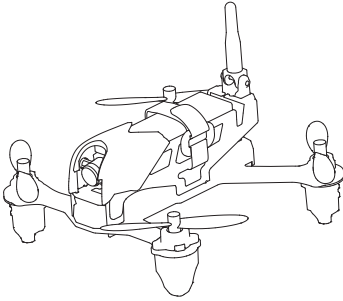

H122D

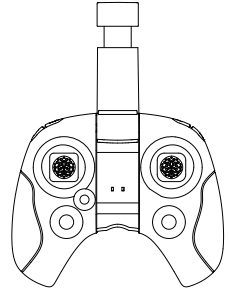

HT015

2. Aircraft + HS001+ HT015 Transmitter+HV002 Video glasses

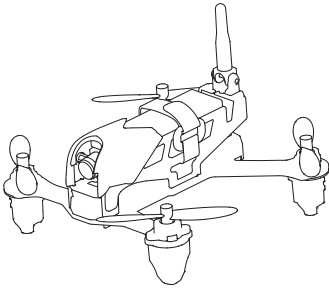

H122D

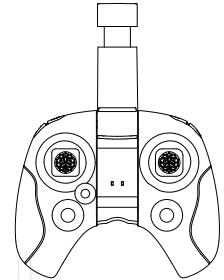

HT015

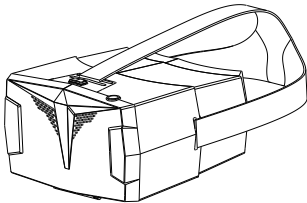

HV002



HS001

Important safety information

Operation: Be extremely careful and responsible when using the quad. Small electronic components can be damaged due to crashes or exposure to moisture/liquid. To avoid any injuries, do not use the quad with broken or damaged components.

Maintenance: Do not try to open or repair the units by yourself. Please contact Hubsan or Hubsan authorized dealers for service. For more information, please visit the official website at www.hubsan.com.

Battery: Do not disassemble, squeeze, impact, burn, drop or trample the battery. Do not short-circuit or put the battery terminal in contact with metal.

Do not expose the battery to temperatures above 60 ° C.

Charge the aircraft battery prior to flight. Use a Hubsan dedicated charger for charging. Keep the battery out of the reach of children and away from any kind of moisture.

Flight: Please be mindful of personal safety and the safety of others while flying.

- Do not fly in bad weather conditions.
- Do not attempt to catch the aircraft while it is in flight.
- This product is intended for experienced pilots over the age of 14.
- After every flight, completely disarm the aircraft motors and disconnect the aircraft from power. Then, you may power off the remote control.

Read the Disclaimer and Safety Guidelines first before use.

Symbol explanation :

 Prohibited operation  Important Notice  Instruction  Explanation/reference

USAGE ADVICE (Hubsan has created the following operational and safety materials)

 «Quick Start Guide»

 «Disclaimer and Safety Guidelines»

Safety Advisory Notice for Lithium-Polymer (LIPO) Batteries

LiPo batteries are different from conventional batteries in that their chemical contents are encased in a relatively lightweight foil packaging. This has the advantage of significantly reducing their weight but it does make them more susceptible to damage if roughly or inappropriately handled. As with all batteries, there is a risk of fire or explosion if safety practices are ignored:

- If you do not plan to fly the quad for a long time, store the battery ~50% charged to maintain battery performance and life.
- Please use Hubsan chargers for battery charging.
- Discharge the battery at 5C current or below. To avoid discharge related battery damage, do not prolong the discharge time.
- Do not charge on carpet to avoid fire.
- Batteries need to be recharged if unused for over 3 months.

1. Do not disassemble or reassemble the battery.
2. Do not short-circuit the battery.
3. Do not use or charge near sources of heat.
4. Do not put the battery in contact with water or any kind of liquid.
5. Do not charge batteries under sunlight or near fire.
6. Do not puncture or subject the battery to force of any kind.
7. Do not throw or manhandle the battery.
8. Never charge a battery that has been damaged, become deformed or swelled.
9. Do not solder on or near the battery.
10. Do not overcharge or over discharge the battery.
11. Do not reverse charge or reverse the battery polarities.
12. Do not connect the battery to a car charger/cigarette lighter or any other kind of unconventional power source.
13. This battery is prohibited for non-designated devices.
14. Do not touch any kind of liquid waste or byproduct from batteries. If skin or clothes come in contact with these substances, please flush with water!
15. Do not mix other types of batteries with lithium batteries.
16. Do not exceed the specified charging time.
17. Do not place the battery in a microwave or in areas of high pressure.
18. Do not expose the battery to the sun.
19. Do not use in environments with high static electricity (64V and above).
20. Do not use or charge in temperatures below 0 °C and above 45 °C.
21. If a newly purchased battery is used, leaking, possesses a bad smell or any other abnormality, return immediately to the vendor.
22. Keep away from the reach of children.
23. Use a dedicated battery charger and follow all charging requirements.
24. Minors who use the battery and its dedicated unit must be supervised by an adult at all times.

Table of Contents

Important safety information -----	1	2.2.4 Installing the TF (Micro-SD) card -----	11
Symbol Explanation -----	1	2.3 HV002 Video glasses -----	11
Usage Advice -----	1	3. Getting ready to fly -----	12
1. The H122D Aircraft -----	4	3.1 Flight environment requirements -----	12
1.1 Aircraft component breakdown-----	4	3.2 Preflight checklist-----	12
1.2 Charging and Installing the aircraft battery-----	5	3.3 The first flight configuration: Aircraft + HT015 Transmitter-----	12
1.3 Installing and Removing the propellers-----	7	3.3.1 Binding the aircraft and transmitter-----	12
1.4 Aircraft LED indicators-----	7	3.3.2 Horizontal calibration-----	13
1.5 Adjusting the aircraft camera angle -----	7	3.3.3 Taking off and landing-----	13
1.6 Installing the TF (Micro-SD) card -----	7	3.3.4 Basic flight operation -----	14
2. The HT015 Transmitter -----	7	3.3.5 Expert mode and Normal mode -----	15
2.1 Getting to know your HT015 -----	8	3.3.6 Acrobatics -----	16
2.1.1 Transmitter component breakdown-----	9	3.4 The second flight configuration: Aircraft + HS001+ HT015 Transmitter +HV002 Video glasses -----	17
2.1.2 HS001 key functions-----	9	3.4.1 Binding the aircraft and transmitter -----	17
2.1.3 Installing the transmitter batteries-----	9	3.4.2 Horizontal calibration-----	18
2.2 HS001 LCD Display -----	9	3.4.3 Installing the HS001 display---	19
2.2.1 Main interface -----	10	3.5 Motor stall protection -----	20
2.2.2 Display component breakdown-----	10	H122D Frequently Asked Questions ---	21
2.2.3 HS001 key functions-----	11	H122D Accessories -----	22

1 The H122D Aircraft

1.1 Getting to know your H122D

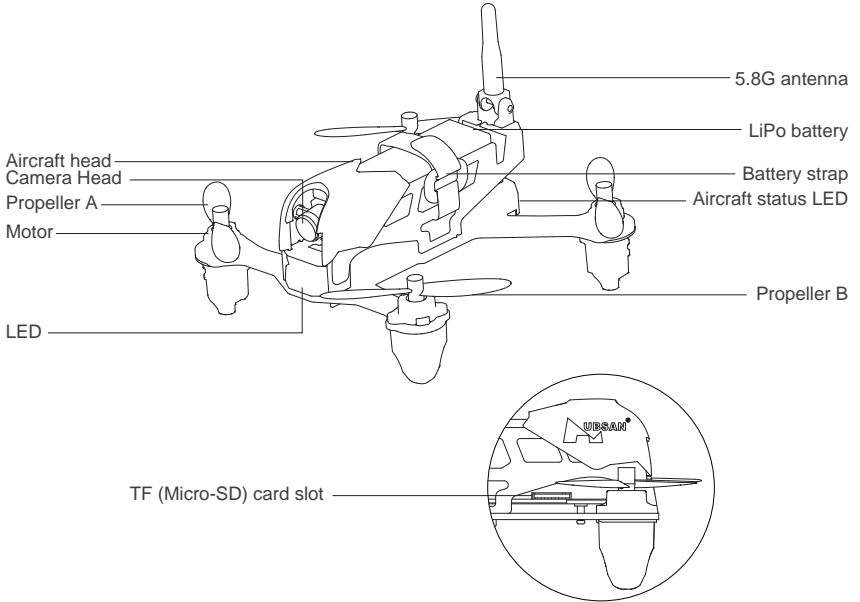

1.2 Charging and Installing the aircraft battery

The H122D aircraft is paired with a rechargeable 7.6v, 710mAh Li-Po. Be sure to use the provided Hubsan dedicated charger for charging. Fully charge the battery before flight.

Connect the charger's USB adapter to a PC terminal and then the battery to the charger. Charging time is approximately 130min; recommended flight time is 6.5 minutes. Be sure to charge the battery before each flight.

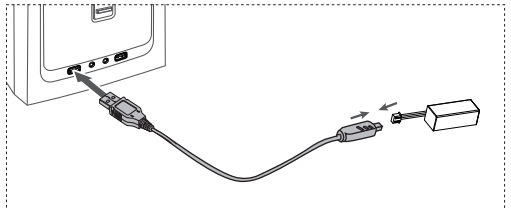

Installation: Push the battery into its compartment with its lines facing away from the unit. Connect it to the drone's power line and coil the power line into the compartment. Be careful to avoid entangling the power line with the propellers.

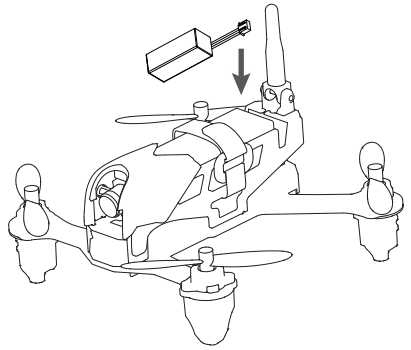

- Make sure the battery is fully charged before each flight.
- Please do not leave unattended while charging.
- When charging is complete, disconnect the charger and battery from power immediately.

1.3 Installing and removing propellers

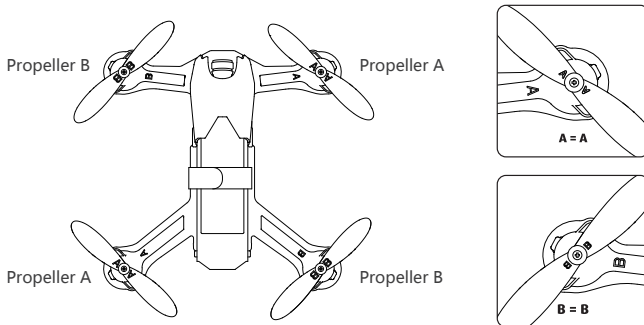

Installation: Before installing propellers for the first time, please check that each Propeller A is matched with motor A and each Propeller B is matched with motor B. Align the "I" with the flat side of the "D" shaped motor shaft. Then use the provided screws and screwdriver to secure each propeller. Propeller A's are paired with black propeller screws and are tightened counterclockwise. Propeller B's are paired with silver propeller screws and are tightened clockwise. (as shown below)

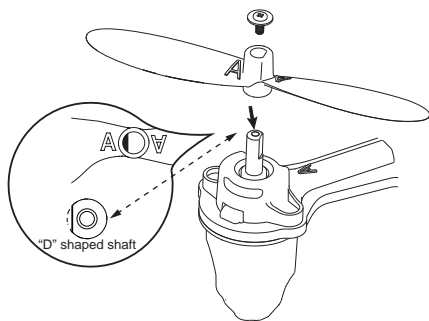
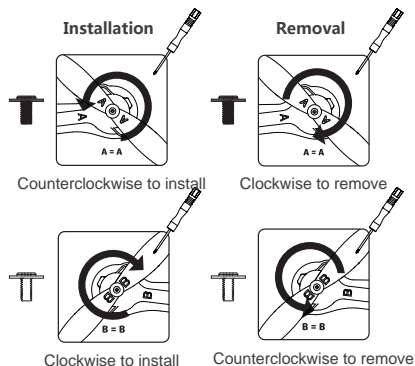

Figure 1



Note: Mind the differing colors of the A and B propeller screws!

1.4 Aircraft LED indicators

LED Status	Function and/or Aircraft status
Headlight (white)	During normal flight, the headlight is a solid white. Users may also opt to turn the headlight off.
Rear LEDs (red)	Power on and start up: All LEDs flash simultaneously
	Flight control connection: When the aircraft is not connected to a transmitter or has been disconnected from a transmitter, the right rear LED will flash slowly. Upon connection with a transmitter, the right rear LED will become solidly lit.
	Horizontal Calibration: Left and right rear LEDs flash alternately. All LEDs turn solid when calibration is complete.
	Photo: When the user takes a photo, both rear LEDs will flash together once.
	Video: When the user records a video, both rear LEDs will flash together slowly.
Video transmission module LEDs (1 red, 1 blue)	Low power: Both rear LEDs will flash together rapidly (this indication takes priority over all others when power is low).
	Power on and initialization: While the aircraft is powering on, the module LEDs will turn on solid simultaneously. After power on is complete, the red LED will flash once and disappear.
	Standby: The red LED is off and the blue LED is solid.
	No SD card present in the aircraft, or error present with card installed: The red LED is off and the blue LED flashes once every second.
	Update: While the aircraft firmware is being updated, the red and blue LEDs flash simultaneously. After the upgrade is complete, the red LED disappears and the blue LED turns solid.
	Photo: When the user takes a photo, the red LED is off and the blue LED flashes once.
Video: When the user records a video, the blue LED is solid and the red LED flashes continuously during the recording process. When the recording is finished, the blue LED remains solid and the red LED disappears.	

1.5 Adjusting the aircraft camera angle

To change the aircraft's camera angle, use a screwdriver to loosen the screws holding the camera head in place. Manually adjust the camera head accordingly as desired (downwards 8 degrees max, upwards 45 degrees max) and firmly tighten the screws afterwards.

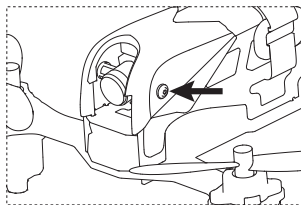

1.6 Installing the TF (Micro-SD) card

Locate the TF (Micro-SD) slot at the bottom of the aircraft. Insert the Micro-SD into the aircraft to take photos and make video recordings.

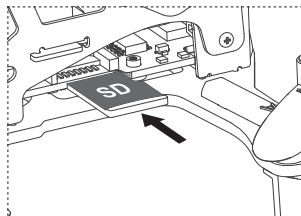

2 The HT015 Transmitter

2.1 Getting to know your HT015

2.1.1 Transmitter component breakdown

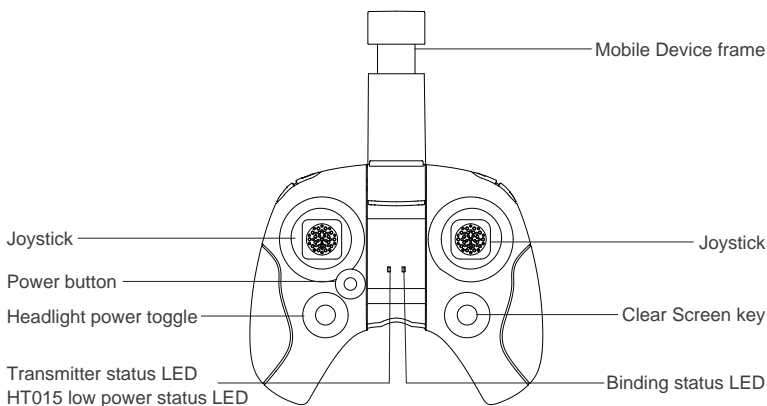

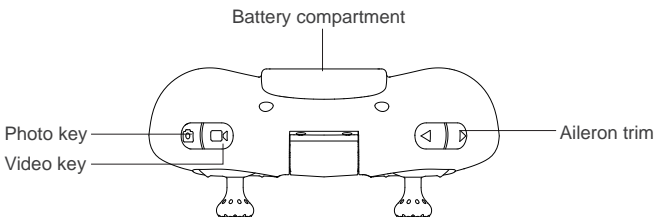

2.1.2 HT015 key functions

No.	Key/button/Switch	Function
1	Throttle/Rudder stick	Push the stick forward or backward and the quadcopter will ascend or descend (respectively). Push the stick left or right and the quadcopter will rotate counterclockwise or clockwise (respectively).
2	Elevator/Aileron stick	Push the stick forward or backward and the quadcopter will fly forwards or backwards (respectively). Push the stick left or right and the quadcopter will fly left or right (respectively).
3	Power button	Long press to power the screen on or off. The transmitter status LED will turn solid upon power on.
4	Binding mode	Hold the Photo key while powering the transmitter on to enter binding mode.
5	Arm/Disarm motors	Pull both joysticks down out and hold the position for 1.5 seconds.
6	Photo key	Short press to take a photo.
7	Video key	Short press to start a video recording; short press again to end it. Note: Users cannot take pictures while recording video. Attempting to do so will end any video recording in progress.
8	Headlight power toggle	Short press to turn the headlight on; short press again to turn it off.
9	Aileron trim	Short press to trim the Aileron
10	Transmitter status LED	Provides information on the transmitter's status as well as power warnings. Normally, the LED is solid. Low power warning: the LED rapidly flashes and the transmitter will beep continuously.
11	Binding status LED	Not connected: the LED is blue, flashing slowly. Connected: the LED is blue and upon connection will beep.
12	Clear Screen key	Short press to clear the screen; short press again to show content.
13	Acro mode	Short press on the throttle (you should feel and hear a click). The transmitter will beep 3 times and enter Acro mode.
14	Sensitivity	Short press on the non-throttle joystick (you should feel and hear a click). Entering Expert mode: Two beeps indicate that the transmitter is in Expert mode. Exiting Expert mode: One beep indicates that the transmitter has exited Expert mode.

2.1.3 Installing the transmitter batteries

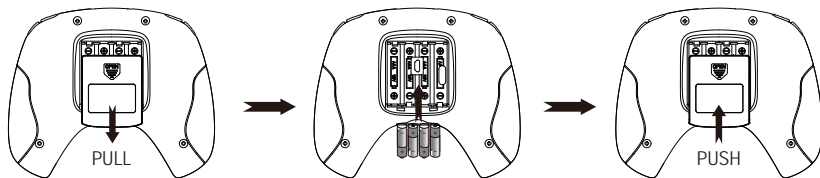

Unscrew the battery door and open the battery compartment.

Install 4 AAA batteries (be sure to match polarities correctly).

Slide the battery door back onto the compartment and fasten with the screw.

- There are two ports located in the battery compartment, used for upgrades. Please **DO NOT** use or connect these ports to any kind of device whatsoever!

2.2 HS001 LCD Display

2.2.1 Main interface

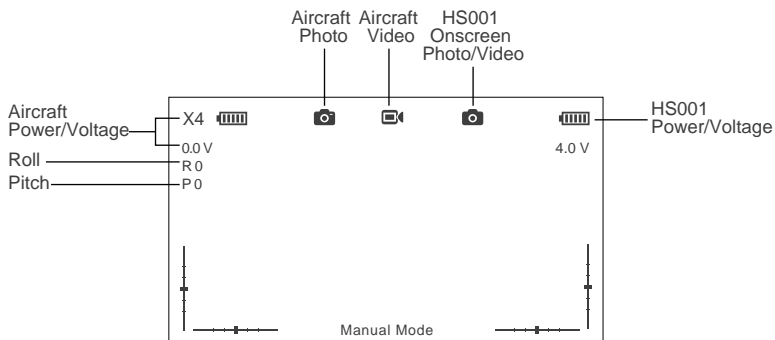

2.2.2 Display component breakdown

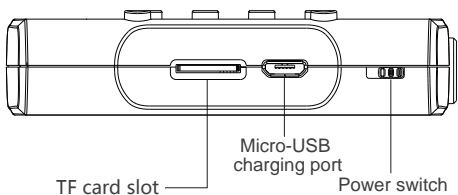

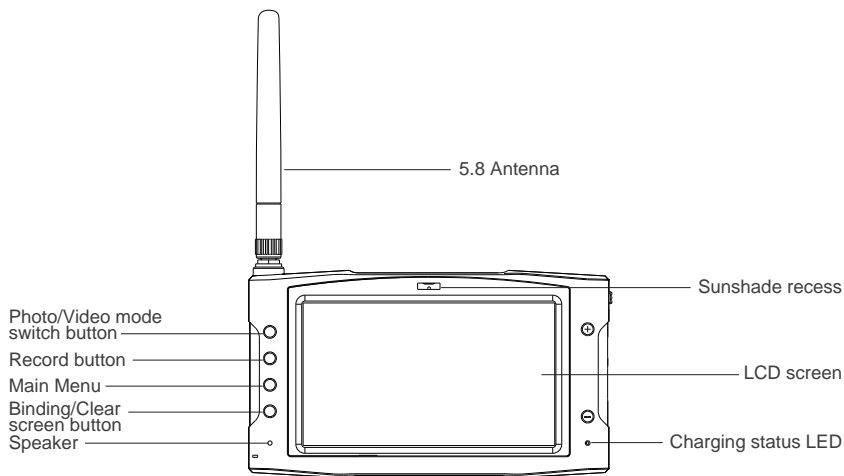

2.2.3 HS001 key functions

No.	Key/button/Switch	Function
1	Power Switch	Push up/ON to turn on the transmitter. Push down/OFF to turn off.
2	Photo/Video mode switch button	Photo/Video mode switch button
3	Photo/Video button	Short press to take photos/start and end video recordings.
4	Main Menu key	Short press to enter the Main Menu. Use in conjunction with the +/- keys to adjust screen brightness/contrast/chrominance/the 5.8GHz frequency and to check firmware information.
5	Binding/Clear screen button	Hold while powering the screen on to initiate a binding. Short press while the screen is on to clear the screen; short press again to show content.
6	TF (Micro-SD) slot	Insert an SD card into the LCD screen's slot to take and store photos and video recordings.
7	Micro-USB port	Used for charging and for updating firmware (only when necessary).
8	Charging status LED	While the screen is charging, the LED is a solid red. After charging is complete, the LED turns solid green.

2.2.4 Installing the TF (Micro-SD) card

Insert the SD card in the TF card slot located on the display's right hand side. To eject the SD card from the slot, push the Micro-SD inwards (it will pop out).

2.3 HV002 Video glasses

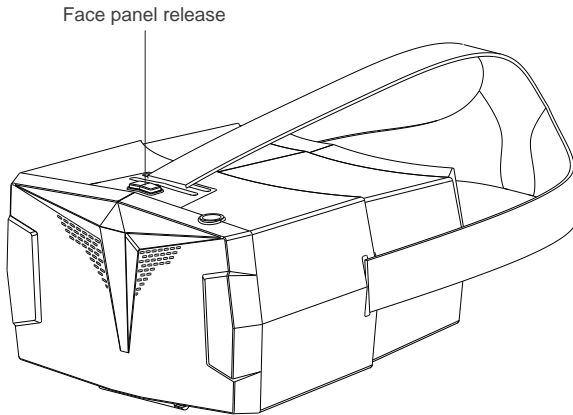

3 Getting ready to fly

After all set up is complete, the aircraft is ready to fly. It is recommended that users implement some kind of flight training (i.e using a simulator for flight practice, seeking professional guidance, etc.) before flying the H122D. Please select an appropriate flight environment for flight.

3.1 Flight environment requirements

- (1) Select an open environment devoid of high rise buildings and tall obstructions (such as trees and poles).
- (2) Do not fly in bad weather conditions (such as in wind, rain or fog).
- (3) Fly the drone in ambient temperatures of 0-40 °C.
- (4) When flying, please stay away from obstructions, crowds, high voltage lines, trees, water, etc.
- (5) To avoid remote control signals interference, do not fly in complex electromagnetic environments (such as venues with radio stations, power plants and towers).
- (6) The H122D cannot be used in or near the Arctic circle or Antarctica.
- (7) Do not fly in no fly zones.
- (8) Do not operate the aircraft near high pressure lines, airports or areas with severe magnetic interference.



High pressure lines

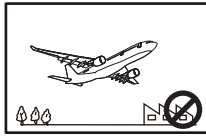

Airports

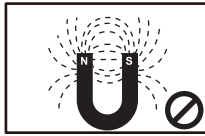

Magnetic interference



Rain

3.2 Pre-flight checklist

- (1) Make sure the aircraft battery and mobile device are charged and have adequate power.
- (2) Confirm that propellers and screws are properly installed.
- (3) If you are taking pictures, insert the Micro-SD card required for taking pictures and videos.
- (4) Verify that the motors arm and spin smoothly.
- (5) Ensure the camera lens is clean.

3.3 The first flight configuration: Aircraft + HT015 Transmitter

3.3.1 Binding the aircraft and transmitter

1. Pull and hold the throttle to its lowest position.
2. Hold down the Photo key and power the transmitter on. The transmitter's status LED will flash red; please do not press or touch any other keys, buttons or sticks while this process is ongoing. Users may let go of the Photo key and throttle. Connect the aircraft to its battery and allow it to bind to the transmitter. The two must be very close to each other; when the bind is successful, the binding status LED will turn green.

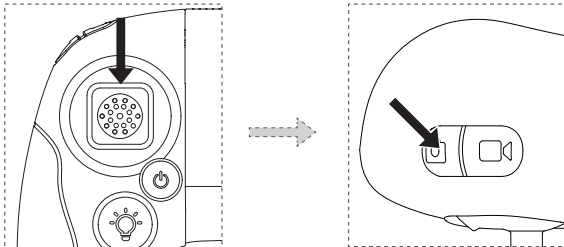

All illustrations are shown in Mode 2 (American hand)

3.3.2 Horizontal calibration

Horizontal calibration is required when the aircraft drifts on the horizontal plane during flight. When this happens, land the aircraft and disarm its motors. Follow the below steps to do a horizontal/gyro calibration.

1. Place the aircraft on a completely flat surface and then follow the below calibration procedure. Hold the left stick to the right side of its socket. Rapidly and continuously wiggle the right stick left and right until the rear red LEDs flash alternately.
2. Calibration is complete when the LED indicators stop flashing. It is recommended that users wait for 15-20 seconds after the calibration is completed before flying again.

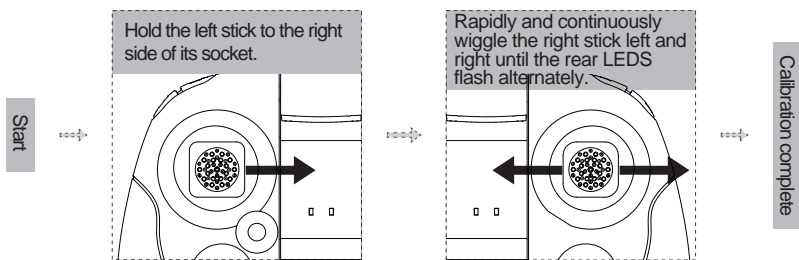

Before performing a Horizontal calibration, please make sure that all motors are completely disarmed and that the aircraft is on a completely flat surface.

3.3.3 Taking off and landing

Takeoff

Simultaneously pull the transmitter joysticks diagonally down-out to arm the motors (as shown in the below figure). Pull the left joystick (throttle) upwards to take off.

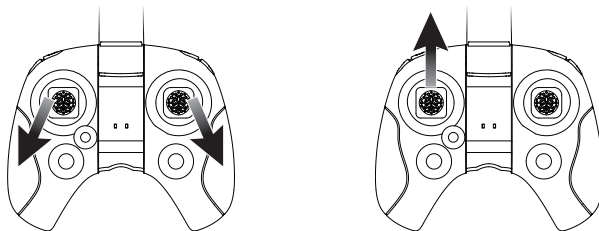

Landing

Slowly and gently pull the throttle joystick down until the copter has completed its descent on the ground. Simultaneously pull the transmitter joysticks diagonally down-out to disarm the motors (as shown in the right figure). After all motors have come to a complete stop, release the joysticks.

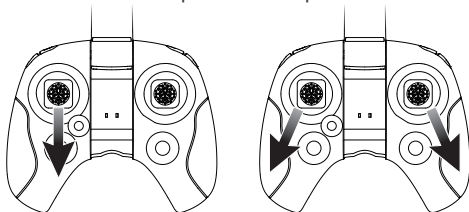

3.3.4 Basic flight operation

Note: When flying the aircraft, be sure to slowly and firmly manage the controls. With every joystick maneuver the aircraft will lose a little power, so be sure to use a little extra throttle to keep the aircraft airborne.

The throttle controls the ascent and descent of the copter.

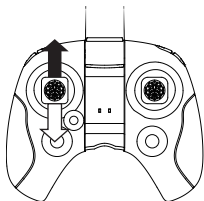

Mode 2 (American hand)

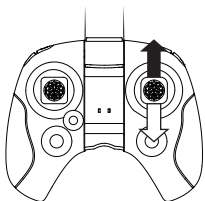

Mode 1 (Japanese hand)

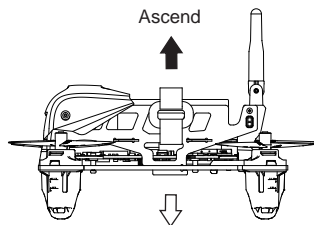

Descend

The rudder is used to control the aircraft's rotations.

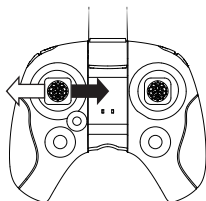

Mode 2 (American hand)

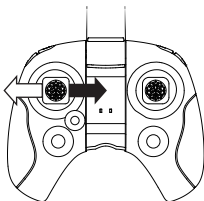

Mode 1 (Japanese hand)

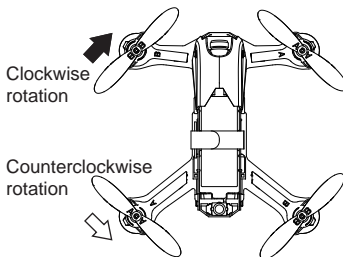

The elevator controls the aircraft's forward and backward movement.

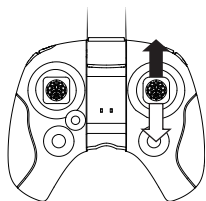

Mode 2 (American hand)

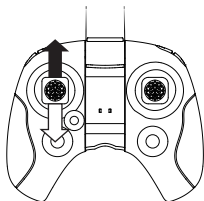

Mode 1 (Japanese hand)

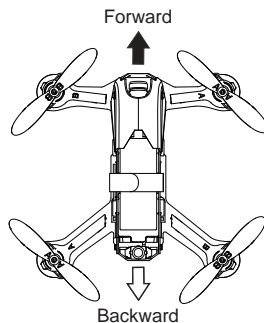

The aileron controls the aircraft's left and right movement.

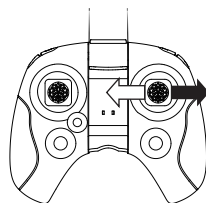

Mode 2 (American hand)

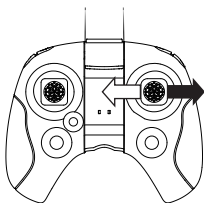

Mode 1 (Japanese hand)

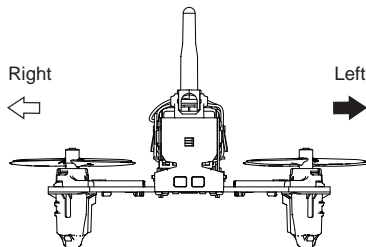

3.3.5 Expert mode and Normal mode

Short press on the non-throttle joystick (you should feel and hear a click) to enter or exit Expert mode. In Expert mode, the aircraft will respond in a very sensitive and nimble fashion.

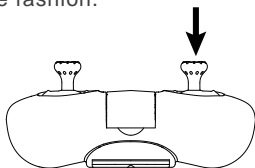

Mode 2 (American hand)

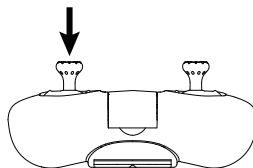

Mode 1 (Japanese hand)

3.3.6 Acrobatics



The H122D is capable of 360° rollovers and flips; you may use this capability by following the below steps. To better perform flips and rolls, please ensure that the aircraft is at a safe height from the ground. It is best to roll and flip the aircraft while it is ascending, so that it more easily maintains its height after flipping or rolling.

1. Left roll

Short press on the throttle (you should feel and hear a click) and push the aileron stick left. The aircraft will perform a left roll.

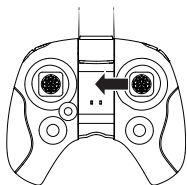

Mode 2
(American hand)

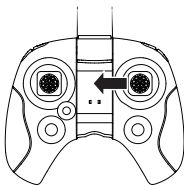

Mode 1
(Japanese hand)

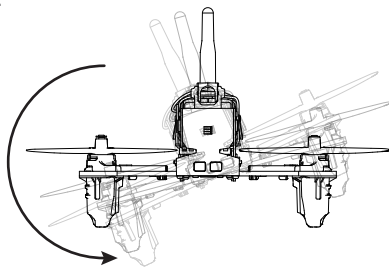

2. Right roll

Short press on the throttle (you should feel and hear a click) and push the aileron stick right. The aircraft will perform a right roll.

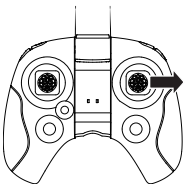

Mode 2
(American hand)

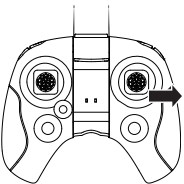

Mode 1
(Japanese hand)

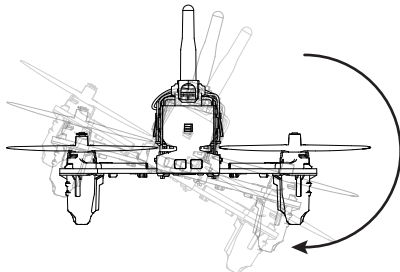

3. Front flip

Short press on the throttle (you should feel and hear a click) and push the aileron stick forward. The aircraft will perform a front flip.

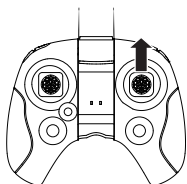

Mode 2
(American hand)

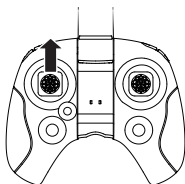

Mode 1
(Japanese hand)

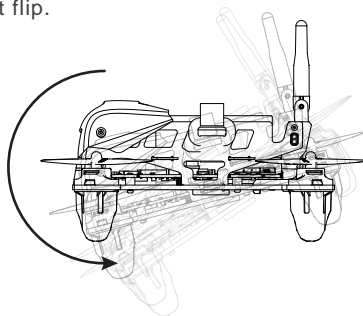

4. Back flip

Short press on the throttle (you should feel and hear a click) and push the aileron stick backward. The aircraft will perform a back flip.

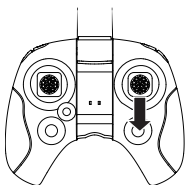

Mode 2
(American hand)

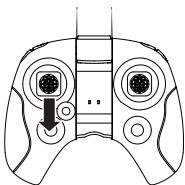

Mode 1
(Japanese hand)

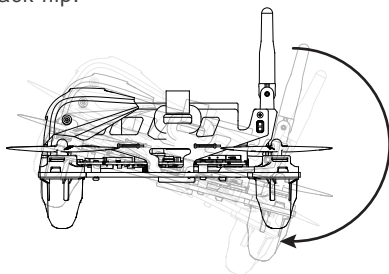

3.4 The second flight configuration: Aircraft + HS001+ HT015 Transmitter +HV002 Video glasses

3.4.1 Binding the aircraft and transmitter

1. Pull and hold the throttle to its lowest position. Hold down the Photo key and power the transmitter on; allow the transmitter to enter binding mode.

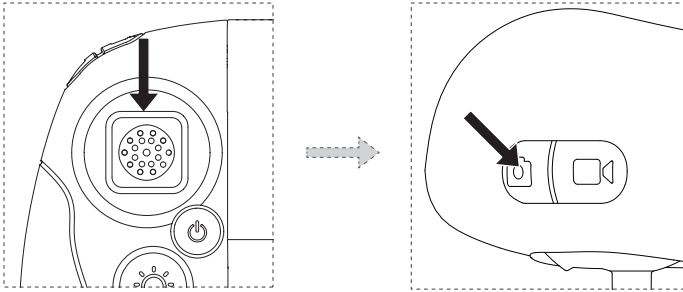

All illustrations are shown in Mode 2 (American hand)

2. Power the HS001 on by pushing the power switch up. Long press the display's binding button (shown below) to allow the HS001 to enter binding mode. The display will beep three times.

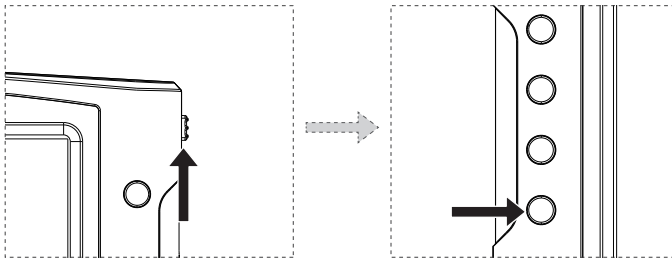

3. Connect the drone to its battery. While all units are in either binding or pairing modes, please do not touch, press or move any of the transmitter joysticks, buttons or keys. Doing so will cause the aircraft to drift or perform unstably during flight. After binding is successful, the transmitter's binding status LED will be a solid blue.

3.4.2 Horizontal calibration

Horizontal calibration is required when the aircraft drifts on the horizontal plane during flight. When this happens, land the aircraft and disarm its motors. Follow the below steps to do a horizontal/gyro calibration.

1. Place the aircraft on a completely flat surface and then follow the below calibration procedure. Hold the left stick to the right side of its socket. Rapidly and continuously wiggle the right stick left and right until the rear red LEDs flash alternately.
2. Calibration is complete when the LED indicators stop flashing. It is recommended that users wait for 15-20 seconds after the calibration is completed before flying again.

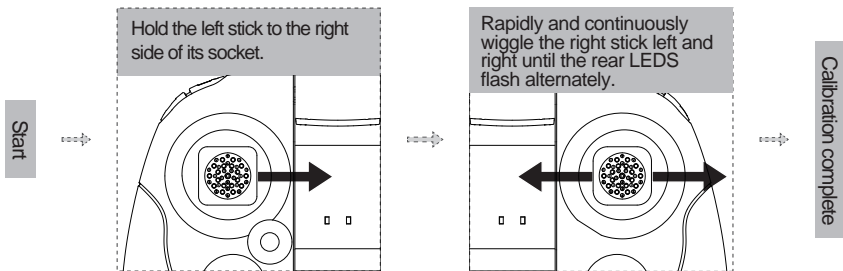

Before performing a Horizontal calibration, please make sure that all motors are completely disarmed and that the aircraft is on a completely flat surface.

3.4.3 Installing the HS001 display

Option 1: Secure the HS001 display to the HT015's mobile device bracket.

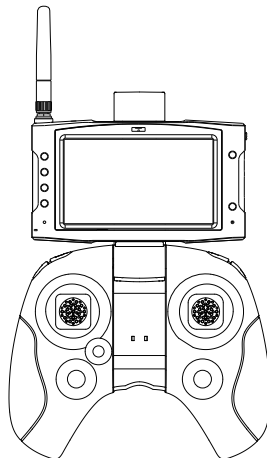

Option 2 (with the HV002 video goggles): Press the release key on the HV002 goggles to release its face panel. Install the HS001 into the exposed compartment and shut the panel. After the installation, one may put the goggles on and adjust to fit with the adjustable head strap.

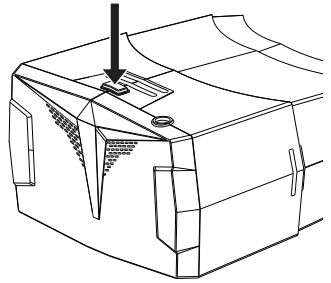

After installing the display, check if the face panel is loose. If yes, please readjust accordingly.

3.5 Motor stall protection

When aircraft crashes or its propellers encounter blockage/obstruction, the motors will automatically disarm to prevent further damage.

H122D Frequently Asked Questions

1. Aircraft and remote control are not pairing

- (1) Check that the aircraft and remote control are both powered on.
- (2) Turn off both the aircraft and remote control. Rebind the aircraft to the remote control by following the rebind directions on page 7 of this guide.

2. No video on the screen or user is experiencing strong video feed interference

- (1) Check whether there are strong sources of wireless interference (i.e. WIFI, electricity, radio tower frequencies, etc). If there are any, please change your flight location.
- (2) Rebind the copter to the transmitter, as the 5.8 and 2.4 frequencies might be interfering with each other.
- (3) Browse through the selection of available 5.8GHz frequencies to find a clean channel.

3. Aircraft/video feed is shaking/shaky

- (1) Check if the aircraft propellers are deformed or broken. Please replace them.
- (2) Check that all aircraft body screws are firmly in place.
- (3) Check whether any motor shafts are broken. Motors must be replaced if the shafts are broken.

4. Cannot take videos or pictures

- (1) Check to see that the SD card is installed in the aircraft prior to power on.
- (2) Make sure the SD card is Class 10 or higher, contains 16GB or 32GB of storage and is formatted to FAT32.

H122D Accessories



H122D-01
Front canopy



H122D-02
Headlight cover+
Rear lamp lens



H122D-03
Antenna base+
Antenna tube sheath+
Rear canopy



H122D-04
Motor case+
Motor mount



H122D-05
Adjustable camera
mount

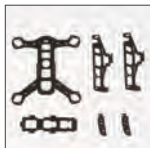

H122D-06
Carbon Fiber
Racing Frame



H122D-07
Camera head



H122D-08
H122D PCB motherboard



H122D-09
Screw set



H122D-10
Propeller A/B



H502-19
Screwdriver



H122D-11
5.8G Antenna



H122D-12
USB charger



H122D-13
HT015 transmitter



H122D-15
HS001 LCD display



HV002
HV002 Video glasses



Sunshade



LCD display charger



Notice: Please read the operating instructions carefully before use!

Warning: Never leave units unattended when charging. Always disconnect the quadcopter from the charger immediately after charging is complete. This is not a toy and is not suitable for children under 14.

www.HUBSAN.com

Product Name: X4 STORM

Company: Shenzhen Hubsan Technology Co., Ltd.

Address: 13th Floor, Block 1, Tower C, Software Industry Base, Xuefu Road, Nanshan District, Shenzhen, China.

Factory: Dongguan Tengsheng Industrial Co., Ltd.

Address: A22# Luyi Street, Tianxin Village, Tangxia Town, Dongguan, China.

Hotline: 0769-82776166 (China)